



# **NETWORK CAMERA**

## **USER MANUAL**

Please read instructions thoroughly before operation and retain it for future reference.

## IMPORTANT SAFEGUARD



All lead-free products offered by the company comply with the requirements of the European law on the Restriction of Hazardous Substances (RoHS) directive, which means our manufacture processes and products are strictly "lead-free" and without the hazardous substances cited in the directive.



The crossed-out wheeled bin mark symbolizes that within the European Union the product must be collected separately at the product end-of-life. This applies to your product and any peripherals marked with this symbol. Do not dispose of these products as unsorted municipal waste. Contact your local dealer for procedures for recycling this equipment.



This apparatus is manufactured to comply with the radio interference requirements.

### ***Federal Communications Commission Interference Statement***

This equipment has been tested and found to comply with the limits for a Class B digital service, pursuant to Part 15 of the FCC rules. These limits are designed to provide reasonable protection against harmful interference in a residential installation.

Any changes or modifications made to this equipment may void the user's authority to operate this equipment. This equipment generates, uses, and can radiate radio frequency energy. If not installed and used in accordance with the instructions, may cause harmful interference to radio communications. However, there is no guarantee that interference will not occur in a particular installation. If this equipment does cause harmful interference to radio or television reception, which can be determined by turning the equipment off and on, the user is encouraged to try to correct the interference by one or more of the following measures:

- Reorient or relocate the receiving antenna.
- Increase the separation between the equipment and receiver.
- Connect the equipment into an outlet on a circuit different from that to which the receiver is connected.
- Consult the dealer or an experienced radio/TV technician for help.
- FCC Caution: Any changes or modifications not expressly approved by the party responsible for compliance could void the user's authority to operate this equipment.
- All external cables connecting to this basic unit must be shielded.  
For cables connecting to PCMCIA cards, see the option manual or installation instructions.

This device complies with Part 15 of the FCC Rules. Operation is subject to the following two conditions:

- (1) This device must not cause harmful interference, and
- (2) This device must accept any interference received, including interference that may cause undesired operation.

### ***Trademark Acknowledgements***

iPad® & iPhone® are the registered trademarks of Apple Inc.

Android™ is a trademark of Google Inc. Use of this trademark is subject to Google Permissions.

Microsoft®, Windows® & Internet Explorer® are registered trademarks of Microsoft Corporation in the United States and/or other countries.

### ***Disclaimer***

We reserve the right to revise or remove any content in this manual at any time. We do not warrant or assume any legal liability or responsibility for the accuracy, completeness, or usefulness of this manual. The content of this manual is subject to change without notice.

This product doesn't have a standby / shutdown mode.

## ***MPEG4 Licensing***

THIS PRODUCT IS LICENSED UNDER THE MPEG4 VISUAL PATENT PORTFOLIO LICENSE FOR THE PERSONAL AND NON-COMMERCIAL USE OF A CONSUMER FOR (i) ENCODING VIDEO IN COMPLIANCE WITH THE MPEG4 VISUAL STANDARD ("MPEG-4 VIDEO") AND/OR (ii) DECODING MPEG4 VIDEO THAT WAS ENCODED BY A CONSUMER ENGAGED IN A PERSONAL AND NON-COMMERCIAL ACTIVITY AND/OR WAS OBTAINED FROM A VIDEO PROVIDER LICENSED BY MPEG LA TO PROVIDE MPEG4 VIDEO. NO LICENSE IS GRANTED OR SHALL BE IMPLIED FOR ANY OTHER USE. ADDITIONAL INFORMATION INCLUDING THAT RELATING TO PROMOTIONAL INTERNAL AND COMMERCIAL USES AND LICENSING MAY BE OBTAINED FROM MPEG LA, LLC. SEE [HTTP://WWW.MPEGLA.COM](http://www.mpegla.com).

## ***GPL Licensing***



This product contains codes which are developed by Third-Party-Companies and which are subject to the GNU General Public License ("GPL") or the GNU Lesser Public License ("LGPL").

The GPL Code used in this product is released without warranty and is subject to the copyright of the corresponding author.

Further source codes which are subject to the GPL-licenses are available upon request.

We are pleased to provide our modifications to the Linux Kernel, as well as a few new commands, and some tools to get you into the code. The codes are provided on the FTP site, and please download them from the following site or you can refer to your distributor:

[http://download.dvrtw.com.tw/GPL/076D\\_Series/arm-linux-2.6.tar.gz](http://download.dvrtw.com.tw/GPL/076D_Series/arm-linux-2.6.tar.gz)

# TABLE OF CONTENTS

1. OVERVIEW.....	1
1.1 Product Features.....	1
1.2 Package Content.....	1
1.3 Product Overview.....	1
1.4 Rear Panel.....	1
1.5 Status Indicator.....	2
2. CAMERA ACCESS WITH INTERNET EXPLORER.....	3
2.1 Camera Login.....	3
2.2 Control Panel Overview.....	3
3. CAMERA CONFIGURATIONS.....	5
3.1 System configuration menu.....	5
3.2 Network.....	6
3.2.1 Network.....	6
3.2.2 QoS.....	6
3.2.3 DDNS.....	6
3.2.4 SNTP.....	7
3.2.5 FTP.....	7
3.2.6 MAIL.....	7
3.2.7 SMS.....	8
3.2.8 Filter.....	8
3.2.9 UPnP / Bonjour.....	9
3.2.10 RTP.....	10
3.3 Camera.....	11
3.3.1 Camera.....	11
3.3.2 Video.....	11
3.3.3 Color.....	11
3.3.4 Advance.....	12
3.4 Trigger.....	12
3.4.1 Trigger.....	12
3.5 General.....	13
3.5.1 General.....	13
3.5.2 Time.....	14
3.5.3 Server Log.....	14
3.5.4 Online.....	15
3.5.5 Account.....	15
3.5.6 Google Maps.....	16
3.5.7 Maintenance.....	16
APPENDIX 1 PRODUCT SPECIFICATIONS.....	18
APPENDIX 2 BIT RATE TABLE FOR REFERENCE.....	19
APPENDIX 3 API ID APPLICATION FOR SMS MESSAGING.....	20
APPENDIX 4 Q&A.....	22

# 1. OVERVIEW

## 1.1 Product Features

- Easy **network setup** with your **iPhone / iPad**
- **ONVIF** standard supported to simplify system integration
- **H.R. image sensor** gives users clear and sharp pictures
- **Remote Surveillance**
  - **Fully compatibility** on **iPhone & iPad**, and **Internet Explorer®** on **Windows®** operating system

## 1.2 Package Content

- |   |   |
|---|---|
| <input type="checkbox"/> Network camera                 | <input type="checkbox"/> Camera Bracket |
| <input type="checkbox"/> Quick Setup with iPhone / iPad | <input type="checkbox"/> Adapter        |

## 1.3 Product Overview

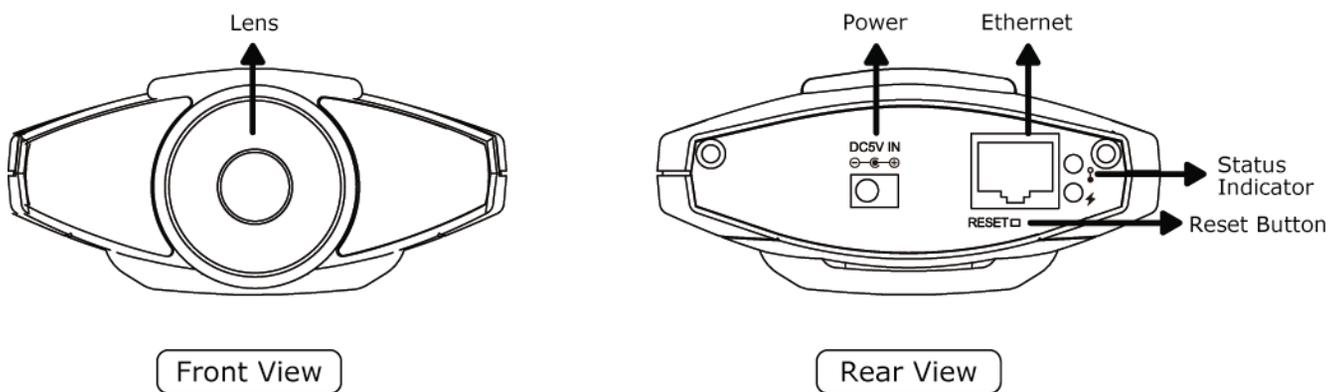

## 1.4 Rear Panel

Ethernet:	Connect a RJ45 network cable.
Power:	Connect the supplied regulated power supply.
Reset Button:	With the power connected, press to reset all parameters, including the IP address to factory default settings. The camera will reboot after default reset. Please do not disconnect your camera during the reset process.
Status Indicator	ⓘ is the indicator for LAN connection, and ⚡ is the indicator for Internet connection. For details, please refer to “1.5 Status Indicator” at page 2.

## 1.5 Status Indicator

ICON	 LAN connection status	 Internet connection status
<b>System Status</b>		
During powering on	Always on	Always on
Reset default	Blinking (on 250 ms, off 250 ms) ●○○●○○●○○●○○	Always off
Upgrade	Blinking (on 250 ms, off 250 ms) ●○○●○○●○○●○○	Blinking (on 250 ms, off 250 ms) ●○○●○○●○○●○○
<b>Connection Status</b>		
LAN connected	Always on	--
LAN disconnected	Blinking (on 100 ms, off 500 ms) ●○○●○○●○○	--
Internet connected	--	Always on
Internet disconnected	--	Blinking (on 100 ms, off 500 ms) ●○○●○○●○○
<b>3G Connection Error on iPhone / iPad / Android Mobile Device</b>		
3G Connection Setting Uncompleted	--	Blinking (on 5 sec, off 0.5 sec, on 0.5 sec, off 0.5 sec, on 5 sec) ●●●●○○●●●●

\* LED blinking frequency - ●LED on / ○LED off

## 2. CAMERA ACCESS WITH INTERNET EXPLORER

This network camera can be accessed via Microsoft® Internet Explorer® and iPhone / iPad / Android mobile devices with our self-developed program “EagleEyes” installed depending on different using situations.

**Note:** For details about accessing network cameras via iPhone / iPad / Android mobile devices, please refer to <http://www.eagleeyesccvt.com>.

Before using the camera, make sure you have configured the network settings, and the network connection is fine.

For network configurations, please refer to:

- **“Quick Setup With iPhone / iPad”** supplied with your camera if you’re using iPhone / iPad, and your network environment is wireless.
- **“ADVANCED NETWORK SETUP”** downloadable from [www.surveillance-download.com/user/n216.swf](http://www.surveillance-download.com/user/n216.swf) if your network environment is not wireless.

### 2.1 Camera Login

Step1: Open your web browser, and key in <http://ipaddress:portnum> in the URL address box.

For example, for the IP address 60.121.46.236 and port No. 888, please key in “<http://60.121.46.236:888>” into the URL address box, and press “Enter”.

Step2: In the login page, key in the user name and password, and enter the security code from the image below if any. Then, click “LOGIN”.

Step3: The wizard is then started.

- To skip the wizard and directly access the camera live view, click “Close”.
- To directly access the camera live view without starting the wizard for the login next time, check “Do not start wizard at login”.

**Note:** If you’re prompted to install “VLC player”, “Software” or “H264 Streaming Viewer”, please agree to proceed the installation. Or, you might not be able to see the live view properly.

Step5: When the login is successful, the live view is shown.

### 2.2 Control Panel Overview

**Note:** The buttons available depend on the model number used and the user level used to log in.

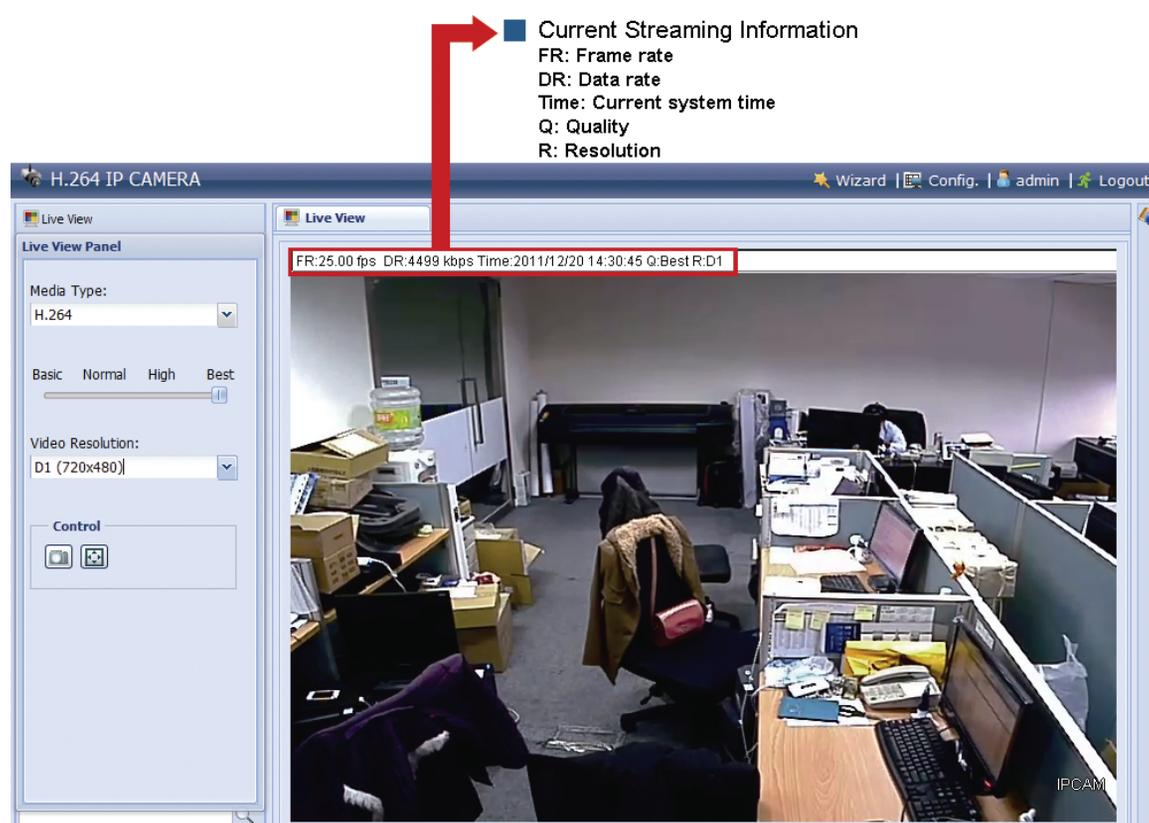

Function	Icon	User Level	Description
Live		Supervisor / Power User / Normal User / Guest	Switch to the live view page.
Config.		Supervisor	Switch to the system configuration page, and the functions available for "Supervisor" and "Power User" are different. For details, please refer to "3.1 System configuration menu" at page 5.
Media Type	--	Supervisor / Power User / Normal User / Guest	Select the image player from the drop-down list: <ul style="list-style-type: none"> <li>■ H.264 / MPEG-4 / Motion JPEG</li> <li>■ QuickTime</li> </ul> <p>QuickTime is Apple Inc.'s multimedia software. You need to have QuickTime installed in your operating system before selecting "QuickTime". When it is selected, you will be promoted to enter the user name and password to access the camera.</p> <ul style="list-style-type: none"> <li>■ VLC</li> </ul>
Quality	--	Supervisor / Power User / Normal User	Click & drag the slider to select the video quality: Basic / Normal / High / Best.
Video Resolution	--	Supervisor / Power User / Normal User	Select the image resolution from the drop list: <ul style="list-style-type: none"> <li>■ D1 (720 x 480)</li> <li>■ CIF (352 x 240)</li> </ul>
Live View Size:		Supervisor / Power User / Normal User	
Full Screen			Click to display the image in full screen. To exit the full screen mode, press "Esc" on your keyboard. <i>This icon appears only when the selected resolution is D1.</i>
Double size			The QVGA resolution is resized to fit into the current live view size. <i>This icon appears only when the selected resolution is CIF.</i>
Snapshot		Supervisor / Power User / Normal User	Click to take a snapshot of the current view on a new window. Right click on the picture and re-save it to the location you want.

## 3. CAMERA CONFIGURATIONS

Users can further configure this network camera by accessing via Internet Explorer.

### 3.1 System configuration menu

Click “Config.” to enter the configuration page.

**Note:** You need to be “Supervisor” to enter the system configuration page. If you’re not a “Supervisor”, please re-log into the camera with the correct user name and password.

The functions are categorized into six menus: Network, Camera, Record Timer, Storage, Trigger and General.

- For details about “Network”, please refer to “3.2 Network” at page 6.
- For details about “Camera”, please refer to “3.3 Camera” at page 10.
- For details about “Trigger”, please refer to “3.4 Trigger” at page 12.
- For details about “General”, please refer to “3.5 General” at page 13.

Main Menu	Sub-Menu	Reference
Network	Network	Configure network settings.
	QoS	Limit the data flow for live streaming.
	DDNS	Enter DDNS information when the network type is PPPOE or DHCP.
	SNTP	Synchronize your camera time with the networked computer systems.
	FTP	Enter the FTP information for event notifications when “FTP” is chosen in “Trigger” → “Trigger”.
	Mail	Enter Email information for event notifications when “Email” is chosen in “Trigger” → “Trigger”.
	SMS	Enter text messaging information for SMS notifications when “SMS” is chosen in “Trigger” → “Trigger”.
	Filter	Choose to permit or block the IP address(es) which can access this camera.
	UPnP	<i>*Suitable for Windows-based operating system.</i> Allow this camera to be detected among devices within the same network area for easy and quick usage.
	Bonjour	<i>*Suitable for Apple Mac-based operating system.</i> Allow this camera to be detected among devices within the same network area for easy and quick usage.
RTP	Set the parameters for video data transmission when you’re using multimedia other than web browsers and Video Viewer for remote access.	
Camera	Camera	1. Rename the camera. 2. Change the place where the camera name is shown on the screen.
	Video	Adjust video-related settings in different video format.
	Color	Adjust the color performance.
	Advance	Adjust the camera parameters if necessary.
Trigger	Trigger	1. Enable / disable the motion detection. 2. Set the motion detection area. 3. Configure how the camera reacts for any event.

Main Menu	Sub-Menu	Reference
General	General	<ol style="list-style-type: none"> <li>1. Select the language of the web browser.</li> <li>2. Check the MAC address of the camera.</li> <li>3. Lock camera access after the specified time.</li> <li>4. Enable or disable LED status indication.</li> </ol>
	Time	Set daylight saving time and the current time.
	Server Log	Check the system event logs.
	Online	Check the current online user(s).
	Account	<ol style="list-style-type: none"> <li>1. Create a new user account with different access privilege.</li> <li>2. Modify or delete an existing user account.</li> </ol>
	Google Maps	Allow you to know where the network camera is.
	Maintenance	<ol style="list-style-type: none"> <li>1. Check the current firmware version and upgrade your camera.</li> <li>2. Copy system configurations.</li> <li>3. Reboot the camera.</li> <li>4. Download the video player to play the recorded data.</li> </ol>

## 3.2 Network

### 3.2.1 Network

You can set the network configuration of the network camera depending on your network type.

For details, please refer to “Advanced Network Setup” from [www.surveillance-download.com/user/n216.swf](http://www.surveillance-download.com/user/n216.swf).

The screenshot shows the 'Network Configuration' web interface. It features several input fields and radio buttons for network settings. The 'IP Type' section has three radio buttons: 'Static IP' (selected), 'PPPoE', and 'DHCP'. Below this are fields for 'Server IP' (192.168.1.10), 'Gateway' (192.168.1.1), 'Net Mask' (255.255.255.0), 'Port' (80), 'DNS1' (168.95.1.1), and 'DNS2' (139.175.55.244). A 'MAC Address' field shows 00:0E:53:20:E7:3E. At the bottom, there are 'Save' and 'Reload' buttons.

### 3.2.2 QoS

QoS, Quality of Service, is the ability to control the data flow for real-time streaming. This function is important if your network bandwidth is insufficient and you have other devices to share the network bandwidth.

Check “QoS Enable”, and set the max. upload rate from 256 to 10240 kbps.

The screenshot shows the 'QoS Configuration' web interface. It includes radio buttons for 'QoS' status: 'Enable' (selected) and 'Disable'. There is a dropdown menu for 'Interface' set to 'Ethernet' and a text input field for 'Max. Upload Rate' set to '4096' kbps. 'Save' and 'Reload' buttons are located at the bottom.

### 3.2.3 DDNS

Select “On” when the selected network type in “Network” is “PPPOE” or “DHCP”.

For details, please refer to “Advanced Network Setup” from [www.surveillance-download.com/user/n216.swf](http://www.surveillance-download.com/user/n216.swf).

The screenshot shows the 'DDNS Configuration' web interface. It features radio buttons for 'DDNS' status: 'Enable' (selected) and 'Disable'. There are three input fields: 'System Name' (default), 'Hostname' (MAC000e531d6ff1) with a domain suffix of .ddns.eagleeyes.tw, and 'E-Mail' (manager@tech.com). 'Save' and 'Reload' buttons are at the bottom.

### 3.2.4 SNTP

SNTP (Simple Network Time Protocol) is used to synchronize your camera time with the networked computer systems.

The SNTP Configuration interface includes the following fields and controls:

- GMT: (GMT+08:00) Taipei
- NTP Server: tock.stdtime.gov.tw
- Sync. Period: Daily
- Server Time: 2011-08-30 20:34:42
- Buttons: Save, Sync, Reload

Function	Description
GMT	Once users choose the time zone, the network camera will adjust the local area time of the system automatically.
NTP Server	Simply use the default SNTP server (For example, tock.stdtime.gov.tw) or change to another server with which users are familiar.
Sync. Period	Select "Daily" to synchronize the camera time with the network time every day or "None" to turn off this function.
Sync	Click and the network camera will synchronize the time with the network time.

### 3.2.5 FTP

Enter the detailed FTP information and click "Save" to confirm. The information you set here will be applied when "FTP" is selected in "Trigger" → "Trigger".

The FTP Configuration interface includes the following fields and controls:

- Username: manager
- Password: [masked]
- Server: 321.382.12.99
- Port: 21
- Directory: upload
- Buttons: Save, Test, Reload

### 3.2.6 MAIL

Enter the detailed e-mail information and click "Save" to confirm. The information you set here will be applied when "Email" is selected in "Trigger" → "Trigger".

The SMTP Configuration interface includes the following fields and controls:

- SMTP Server: smtp.gmail.com
- Port: 465
- Mail From: manager
- SSL Encryption:  Yes  No
- Verify Password:  Yes  No
- Username: manager
- Password: [masked]
- Buttons: Save, Test, Reload

The E-Mail Address List interface includes the following table:

Receiver Name	E-Mail Address
boss	boss@tech.com

Function	Description
SMTP Server	Enter the SMTP server address provided from your e-mail system supplier.
Port	Enter the port number provided from your e-mail system supplier. If this column is left blank, the e-mail server will use port 25 to send e-mails.
Mail From	Enter the name of the sender.
SSL Encryption	Select "Yes" if your e-mail server is using SSL encryption to protect your e-mail content from unauthorized access.
Verify Password	Some mail servers are required to verify the password. Please enter the "user name" and "password".
E-Mail Address List	Add the e-mail address(s) of the assigned recipient(s).
Test	When all information is entered, click "Test Mail" to try if the receipt.

## 4.4.7 SMS

**Note:** Before using this function, you need to apply an API ID from the mobile messaging company, Clickatell, and you will be charged starting from the 11<sup>th</sup> message. For details, please refer to "APPENDIX 3 API ID APPLICATION FOR SMS MESSAGING" at page 20.

Enter the detailed information needed for text messaging, and click "Save" to confirm. The information you set here will be applied when "SMS" is selected in "General" → "Trigger".

The screenshot shows the 'SMS Configuration' window. It contains the following fields and controls:

- System:** A dropdown menu with 'clickatell' selected.
- Username:** A text input field containing 'tech'.
- Password:** A text input field with masked characters '\*\*\*\*\*'.
- API ID:** A text input field containing '3281378'.
- Recipient:** A text input field containing '+886912665475'.
- Transfer Interval:** A dropdown menu with '15' selected, followed by the text 'Minute(s)' and a 'Reset Counter' button.
- Message:** A text area containing '[192.168.1.10] unauthorized access!' and a checked checkbox for 'Include Hostname or IP'.
- Buttons:** 'Save', 'Test', and 'Reload' buttons are located at the bottom of the form.

Function	Description
System	The text messaging service provider is Clickatell.
User name / Password	Enter the account user name and password you created in Clickatell.
API ID	Enter the API ID you applied from Clickatell.
Recipient	Click "Add" to enter the phone number, including the country code, to receive the text message. Five sets of phone numbers are allowed.
Transfer Interval	Set the interval time in minutes between two-message sending. The options are 0, 15, 30 & 60.
Reset Counter	Click to restart the text messaging, and the SMS will be sent after the specified time interval since you click this button.
Message	Enter the text content (up to 70 characters) you want to send with the text message.
Test	To know whether your SMS setting is correct, click this button to immediately send a SMS to your phone. Note: This testing is not free and you will be charged for SMS sending base on your local rate.

## 3.2.8 Filter

Choose to permit or block the IP address(es) which can access this camera, and click "Save" to confirm.

The screenshot shows the 'Filter Configuration' window. It contains the following fields and controls:

- Error Count:** A text input field containing '3'.
- Error Lock Time:** A text input field containing '1', followed by the text 'Minute(s)'.
- Echo Request:** Radio buttons for 'Non-Block' (selected) and 'Block'.
- IP/MAC Filter Configuration:**
  - IP/MAC Filter:** Radio buttons for 'Enable' (selected) and 'Disable'.
  - IP/MAC Filter Policy:** Radio buttons for 'Allow' (selected) and 'Deny'.
- IP/MAC Filter Rules:** A table with one rule:
 

Rule	Action
192.168.1.23	<input type="button" value="Add"/> <input type="button" value="Delete"/> <input type="button" value="Help"/>
- Buttons:** 'Save' and 'Reload' buttons are located at the bottom of the form.

Function	Description
<b>Filter Configuration</b>	
Error Count	Set the maximum count for login failure. When the maximum count is reached, the IP address trying to access the network camera will be locked.
Error Lock Time	Set the lock time in minutes when the maximum count of error login for an IP address is reached.
Echo Request	Select "Non-Block" to allow other users to use the ping command to detect the IP address of your network camera, or "Block" to deny the ping command request.
<b>IP/MAC Filter Configuration</b>	
IP/MAC Filter	Choose to enable or disable the filter function.
IP/MAC Filter Policy	If "Enable" is selected, choose whether you want to permit (Allow) or block (Deny) the IP address list below.
<b>IP/MAC Filter Rules</b>	
Rule	<ul style="list-style-type: none"> <li>To add an item to the IP address list, key in the IP address in "Rule", and click "Add".</li> <li>To remove an existing item in the IP address list, click the item you want to remove, and click "Delete".</li> </ul>

### 3.2.9 UPnP / Bonjour

"UPnP" stands for "Universal Plug and Play", which allows devices to connect seamlessly in the home and corporate environments and simplify installation of computer components, and is only suitable for Microsoft Windows-based operating system.

"Bonjour" functions the same as "UPnP", but it's only suitable for Apple Mac-based operating system.

#### ➤ UPnP

#### ➤ Bonjour

Check "Enable" to allow the network camera to be detected among devices within the same network area, and set the identification name of the camera in "Friendly name".

When this function is activated, the other PC within the same domain as this camera will be able to search this camera in:

- "Network Neighbor" with the identification name set in "Friendly name" for Windows-based PC, or
- "Finder" (finder) or "Bookmark" with the identification name set in "Device Name" for Mac-based PC.

Double-click it to quickly open the web browser for camera access.

#### **Port Mapping (Available only in UPnP)**

This function can eliminate the need to additionally access the router for port forwarding.

For details, please refer to "Advanced Network Setup" from [www.surveillance-download.com/user/n216.swf](http://www.surveillance-download.com/user/n216.swf).

---

**Note:** Before using this function, make sure your router supports UPnP, and this function is enabled. If not, please access your router additionally for port forwarding.

---

When “Port Mapping” is set to “Enable”, the system will automatically assign an IP address or port number for you if no IP address or port number is entered.



**Note:** When the configurations are saved successfully, you’ll see a message indicating the IP address and port number assigned to this network camera.

### 3.2.10 RTP

The Real-time Transport Protocol (RTP) is an Internet protocol standard to manage the real-time transmission of multimedia, such as VLC player.

The media player you want to use for remote access must support RTP transmission for this function to work normally.

**Note:** When you’re about to end the remote access, please press the stop button on your media player first, and then close the program. This is to ensure the server receives the stop command, and also help to protect the server from redundant data transmission.

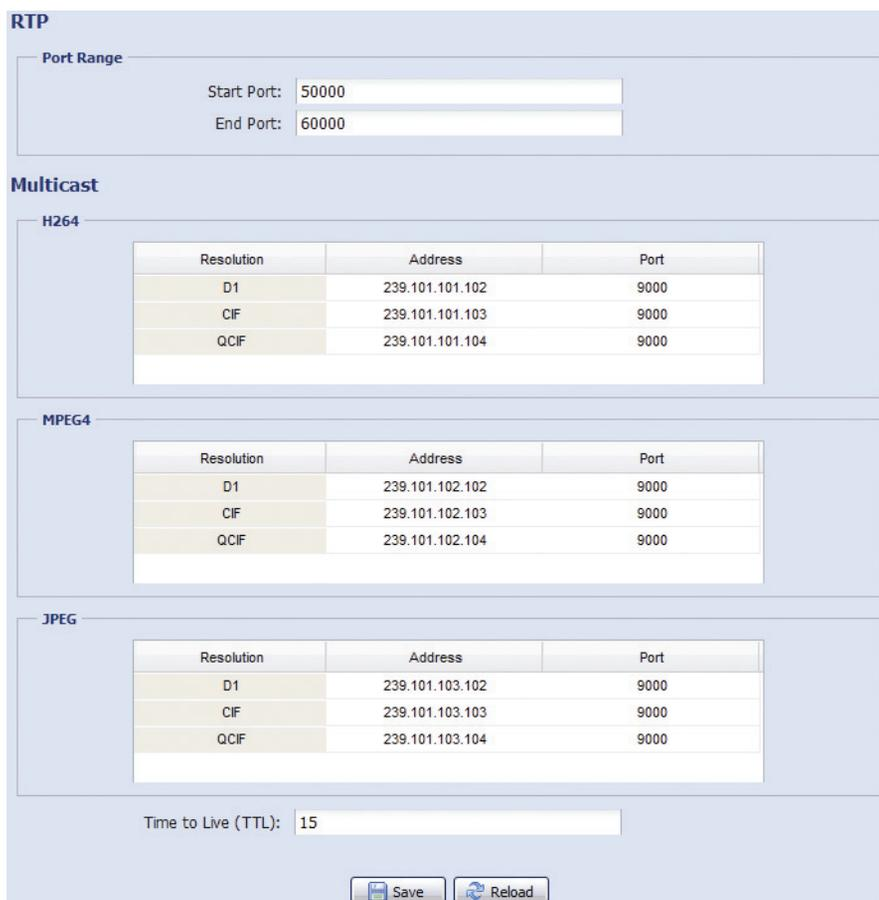

Function	Description
<p>■ <b>Port Range</b> The port range used by RTP is limited, and preserving 100 ports between the start port and end port is necessary.</p>	
Start Port	The range of the start port is 1024 ~ 65434.
End Port	The range of the end port is 1124 ~ 65534.
<p>■ <b>Multicast</b></p>	
Address and port for H264 / MPEG4 / JPEG transmission	Set a specific address and port for multicast of each stream format (H264/ MPEG4/ JPEG). The range of the address is limited between 224.0.0.1 ~ 239.255.255.255. The port for multicast must be an even number.
Time to Live (TTL)	The range of Time to Live of the package is between 1 ~ 255. As soon as Time to Live of the package is 0, it will be dropped.

## 3.3 Camera

### 3.3.1 Camera

Rename the camera, and change the place where the camera name is shown on the screen, UP-LEFT / UP-RIGHT / DOWN-LEFT / DOWN-RIGHT.

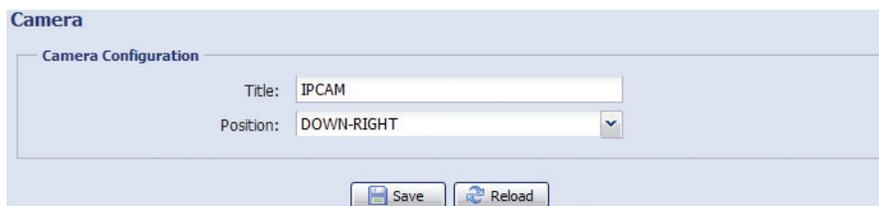

### 3.3.2 Video

Adjust video-related settings in different video format.

- “Quality” is related to image clearness.
- “FPS” is related to the fluency of the video. The more the FPS, the more fluent the video.
- “Max Bit Rate” is the maximum limitation of data transmission in the selected image format and resolution.

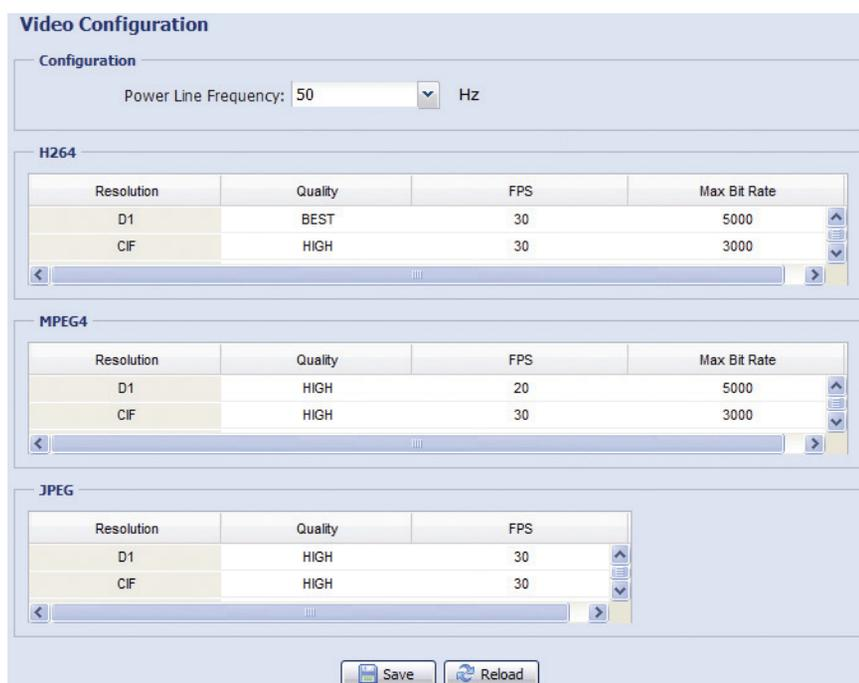

### 3.3.3 Color

Adjust the color performance from Brightness, Contrast and Saturation. Click and drag the slider to preview the color change on the right side of this page and adjust the image color.

To restore the default values, click “Back to Default”.

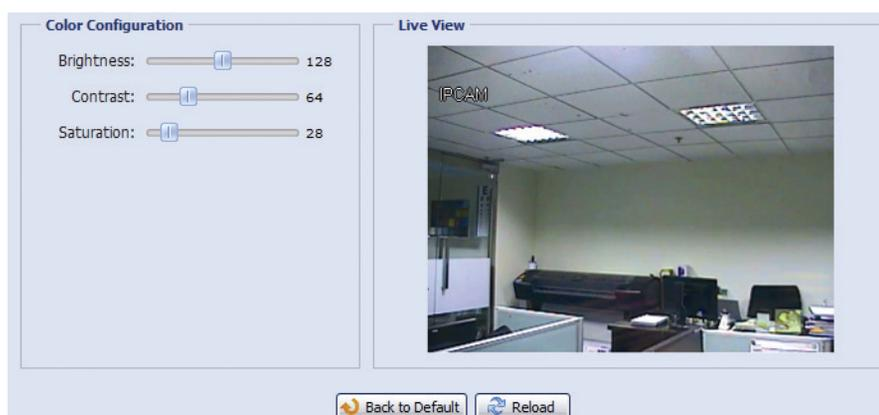

### 3.3.4 Advance

Adjust the camera parameters if necessary.

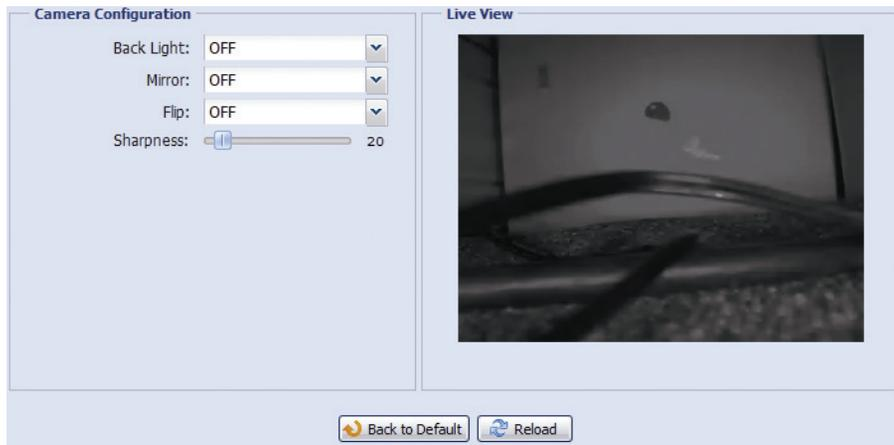

Item	Description
Back Light	It is the function to adjust the image to compensate for an area that is overpowered by brightness because of excessive light. The image will be properly exposed for clearness. Select to activate (ON) or disable (OFF) this function. Note: This function is available only in the day mode.
Mirror	Select "ON" to rotate the images horizontally based on your installation situation when necessary.
Flip	Select "ON" to rotate the image 180° when necessary.
Sharpness	Sharpness enhances the clarity of image detail by adjusting the aperture and sharpening the edges in the pictures. Hold and drag the slider to adjust the level of sharpness from 0 ~ 100. The higher the value, the sharper the image.

## 3.4 Trigger

### 3.4.1 Trigger

You can configure how this camera reacts when there's a motion event.

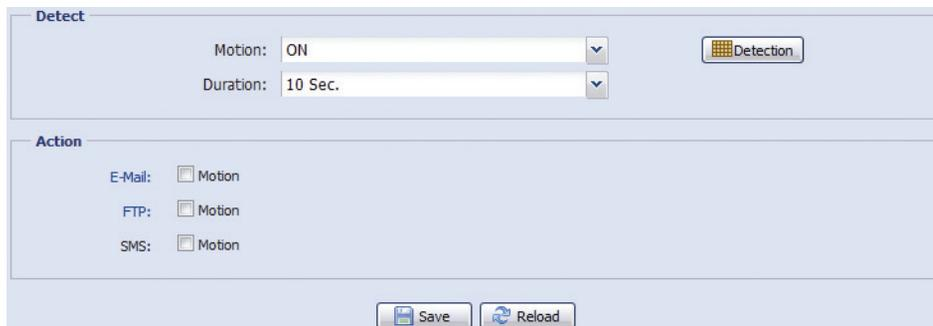

#### ◆ Detect

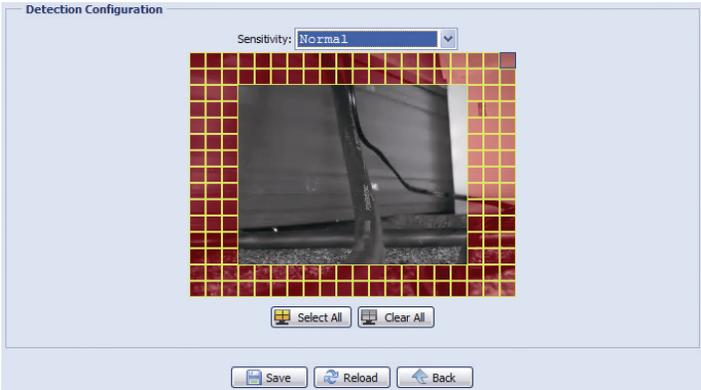
Item	Description
Motion	<p>Enable or disable motion detection. <i>Motion detection is not supported when the stream format is Motion JPEG.</i></p> <p>When "Enable" is selected, click "Detection" to enter the motion detection area setting page as follows:</p>  <p><b>Sensitivity:</b> Set the detection sensitivity from the drop-down list: High, Normal or Low.</p> <p><b>Area Setting:</b> Set the motion detection area by selecting the area grids with your mouse. Pink grids represent the area that is not being detected while the transparent grids are the area under detection. You can set multiple areas under detection. Click "Clear All" to set the whole area undetected.</p>

Item	Description
	Click "Select All" to set the whole area under detection.
Duration	Set the duration time for trigger recording (5 / 10 / 20 / 40 seconds).

◆ Action

Here defines how the camera delivers alerts to you for any event.

Item	Description
E-Mail	Select the event type you want to receive E-mail notifications when it occurs. Then, click the title "E-Mail" (in blue) to configure the media type (H264 / JPEG / MPEG4), file format (AVC / AVI), and record time (1 ~ 5 seconds) for the event video clip. The camera will send the captured video clip to the E-mail address(s) you assigned in "Network" → "Mail" once the selected event type occurs.
FTP	Select the event type you want to receive FTP notifications when it occurs. Then, click the title "FTP" (in blue) to configure the media type (H264 / JPEG / MPEG4), file format (AVC / AVI), and record time (1 ~ 5 seconds) for the event video clip. The camera will upload the captured video clip to the FTP site you assigned in "Network" → "Mail" once the selected event type occurs.
SMS	Select the event type you want to receive a text message when it occurs. The camera will send a text message to the mobile phone number you assigned in "Network" → "SMS" once the selected event type occurs.

## 3.5 General

### 3.5.1 General

To change the language of UI interface, select from the drop-down list in "Language".

To allow the status LED indicators to show the status as indicated in "1.5 Status Indicator" at page 2, select "Enable" in "Status LED Mode"; to hide the status, select "OFF"; to only show the error status, select "Temporary Disable".

---

**Note:** The status LED mode will be restored to "Enable" after camera reboot when "Temporary OFF" is selected.

---

To lock camera access when it's not used after the specified time, select "5 MIN", "15 MIN" or "30 MIN" from the drop-down list of "Auto Lock Time", or select "NEVER" to disable this function.

---

**Note:** When the camera access is locked after the specified time, to resume camera access, please enter the password.

---

The screenshot displays the 'General Configuration' page. It features a table-like layout with the following settings:

- Language: English
- Status LED Mode: Enable
- Auto Lock Time: 15 MIN
- MAC Address: 00:0E:53:E6:29:B3

At the bottom of the configuration area, there are two buttons: 'Save' and 'Reload'.

### 3.5.2 Time

Set daylight saving time and the current time, and click “Save” to confirm.

**Time**

**Time Configuration**

OSD:  Enable  Disable

Date:

Time:  :  :

---

**Daylight Saving Time**

**Daylight Saving Time Configuration**

Daylight Saving Time:  Enable  Disable

Start Time:     :  (HH:MM)

End Time:     :  (HH:MM)

Adjust Time:  :  (HH:MM)

Function	Description
<b>■ Time Configuration</b>	
Date	Set the current date.
Time	Set the current time.
<b>■ Daylight Saving Time Configuration</b>	
Daylight Saving Time	Specify whether to use daylight saving time (Enable / Disable).
	If this function is enabled, set the time period (Start Time / End Time), and adjust the daylight saving time in hours (Adjust Time).

### 3.5.3 Server Log

To quickly search the system logs you want by event type, click “Prev. Page” or “Next Page” to find the logs you want, or check the event type(s) and click “Reload” to start searching.

To clear all system event logs, click “Clear All”.

**Server Log List**

No.	Event	Time	Result
1	Remote Login	2011/08/30 20:54:41	admin
2	Remote Login	2011/08/30 20:29:58	admin
3	Remote Login	2011/08/30 18:22:08	admin
4	SNTP Update	2011/08/30 18:20:06	Failed
5	Remote Login	2011/08/30 18:20:03	admin
6	Power On	2011/08/30 18:19:24	ON
7	Power On	2011/08/30 18:18:46	OFF
8	Remote Login	2011/08/30 18:11:21	admin
9	Remote Login	2011/08/30 18:11:18	admin
10	Remote Login	2011/08/30 18:07:10	admin
11	Remote Login	2011/08/30 18:03:19	admin
12	Remote Login	2011/08/30 18:02:15	admin
13	Remote Login	2011/08/30 18:02:07	admin
14	Remote Login	2011/08/30 18:01:51	admin
15	Remote Login	2011/08/30 17:57:01	admin
16	Remote Login	2011/08/30 17:56:55	admin
17	Remote Login	2011/08/30 17:56:53	admin
18	Remote Login	2011/08/30 17:54:44	admin
19	SNTP Update	2011/08/30 17:50:48	Failed
20	Power On	2011/08/30 17:50:07	ON

### 3.5.4 Online

You can check the current online user(s) with respective online information. To refresh the list, click “Reload”.

- To allow anonymous login, select “Enable” in “Anonymous Viewer Login”.
- To disable image code verification at login, select “No” in “Login with CAPTCHA Image”.

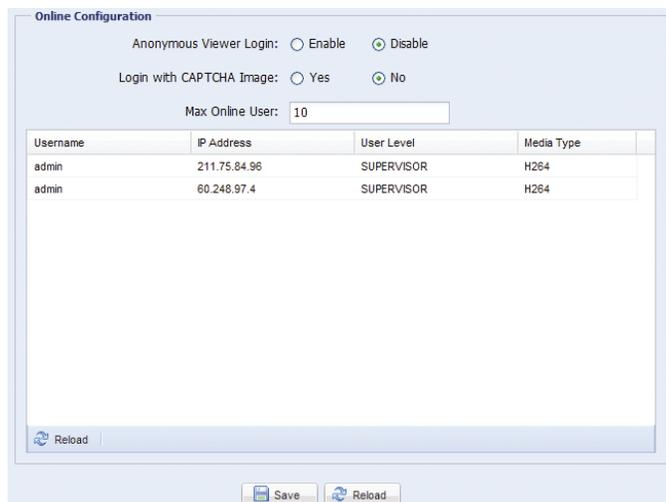

### 3.5.5 Account

You can create a new account with different user access privilege, or delete or modify an existing account setting.

#### How to create a new account

Step1: Click “New”, and fill in the following columns.

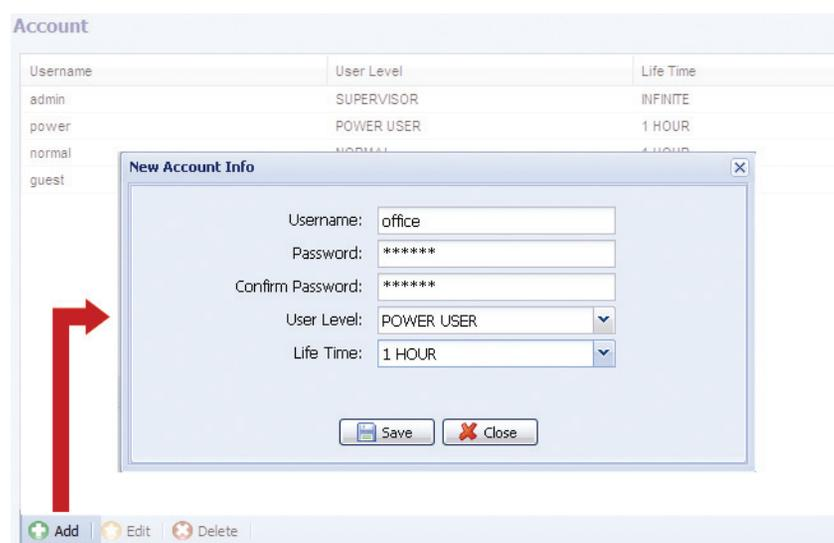

Column	Description
User Name	Set a user name that will be used for camera access. The user name allows up to 16 alphanumeric characters.
Password	Set the password that will be used for remote login. The password allows up to 16 alphanumeric characters.
Confirm Password	Enter the password again to confirm.
User Level	Set the security level of an account to give the permission to control different functions. There are four user levels: SUPERVISOR, POWER USER, NORMAL USER and GUEST.
Life Time	Select how long this account is allowed to stay online (1 MIN / 5 MIN / 10 MIN / 1 HOUR / 1 DAY / INFINITE)

Step2: Then, click “Save” to save your setting and create a new account.

#### How to modify or delete an existing account

Step1: Select the account you want to modify or delete.

Step2: To modify the account, click “Edit” to change the settings, and click “Save”.

To remove the account, click “Delete”.

---

**Note:** It's not allowed to remove an account when there's only one account in the account list.

---

### 3.5.6 Google Maps

This function is used to let you know where the network camera is.

The system will prompt you to apply a Google Maps Key if your access is denied. Please follow the instructions below when you're denied:

Step1: Click "Sign up for a Google Maps key" to enter the application page.

Step2: Check the terms and conditions, and enter the IP address of the network camera. Then, click "Generate API Key".

Step3: Copy the generated API key, and click "Update Google Maps Key" on the web browser to paste it.

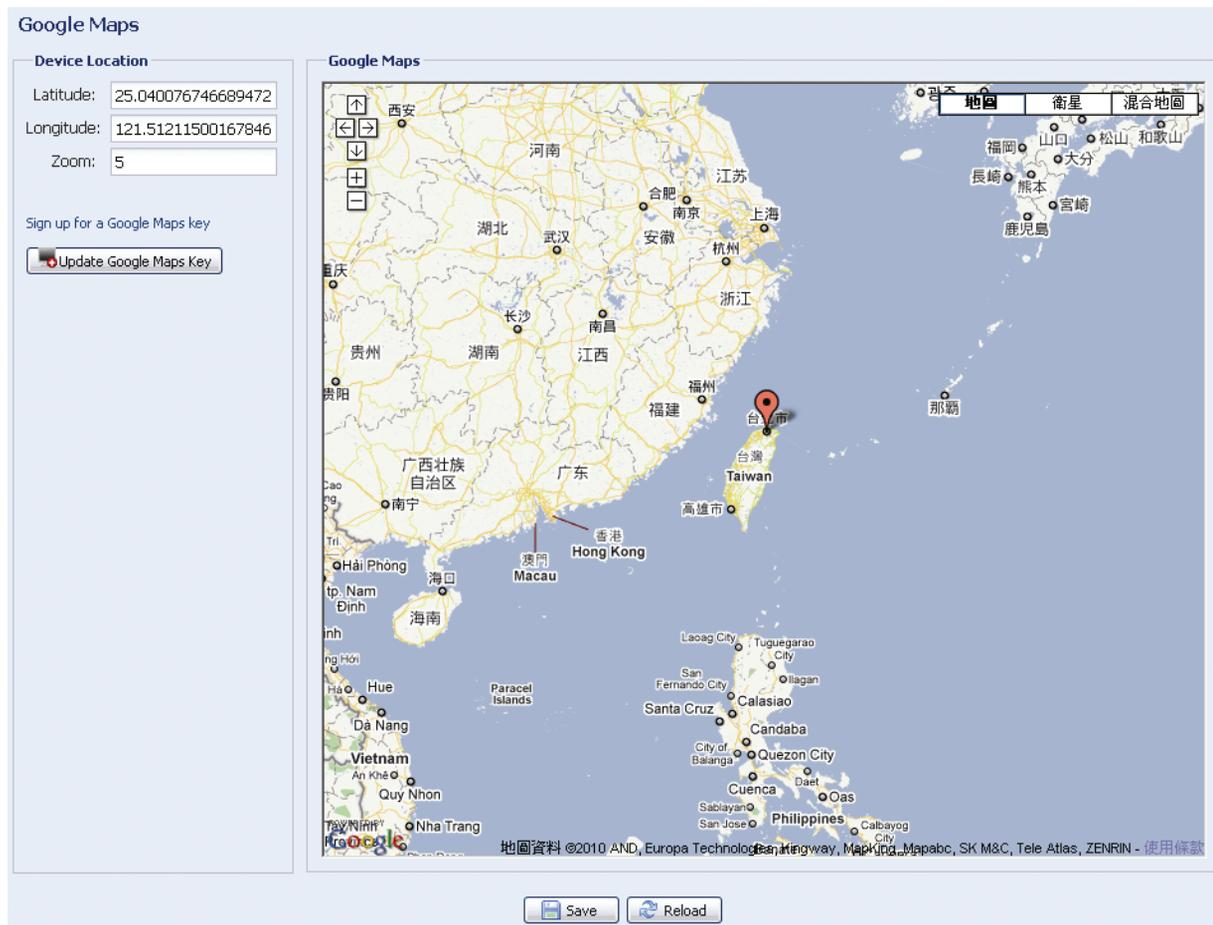

### 3.5.7 Maintenance

#### Firmware Upgrade

This function is used when users need to upgrade the camera for function scalability.

---

**Note:** Before using this function, make sure you have the correct upgrade files provided by your installer or distributor.

---

**Note:** The event videos saved in the camera will be removed after firmware upgrade. Make sure you've copied important events to your PC before firmware upgrade.

---

Step1: Select  to browse to where you save the upgrade files, and select them one by one until all files are selected (up to four files).

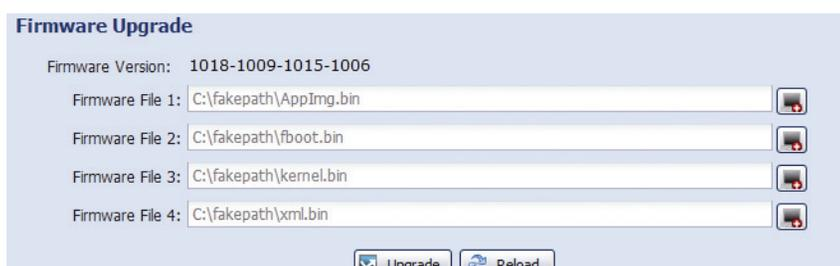

Step2: Select "Upgrade" to start system upgrading.

---

**Note:** You'll be prompted to keep current configurations. It's recommended to keep them, or all configurations will be restored to default values after upgrade.

---

**Note:** It takes a few minutes to finish the upgrade process. Do not disconnect the power during firmware upgrade, or the upgrade may be failed. The camera will reboot after the upgrade.

---

### System Configuration Backup

This function is used to copy your system configuration to a "System.bin" file.

You may import the same system configuration to another camera, or restore your system configuration when the camera is reset to default values.

Select "System.bin" in "Firmware Upgrade", and select "Upgrade" to import the system configuration.

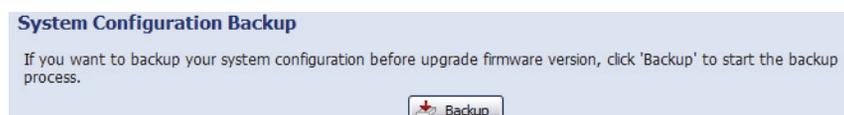

### System Reboot

Select "Reboot" to restart your camera if needed.

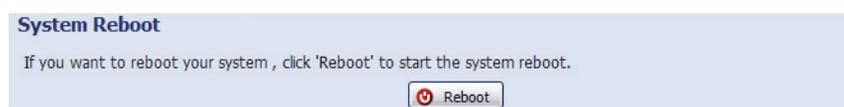

### Player Download

To see the event video clips downloaded to your PC, you need to first install our own video player in your PC. Select "Free Download" to download the video player, and double click the file to install it.



# APPENDIX 1 PRODUCT SPECIFICATIONS

<b>AVN216</b>	
<b>■ Network</b>	
Network Compression	H.264 / MPEG4 / MJPEG
Multiple Video Streaming (Encode Modes, IPS, Resolution)	3 (H.264, MJPEG, MPEG4)
LAN Port	YES
LAN Speed	10/100 Based-T Ethernet
Supported Protocols	DDNS, PPPoE, DHCP, NTP, SNTP, TCP/IP, ICMP, SMTP, FTP, HTTP, RTP, RTSP, RTCP, IPv4, Bonjour, UPnP, DNS, UDP, IGMP, QoS
ONVIF Compatible	YES
Frame Rate	NTSC: 30 FPS / PAL: 25
Number of Online Users	10
Security	<ol style="list-style-type: none"> <li>1. Multiple user access levels with password</li> <li>2. IP address filtering</li> <li>3. Digest authentication</li> </ol>
Remote Access	<ol style="list-style-type: none"> <li>1. Internet Explorer on Windows operating system</li> <li>2. EagleEyes on iPhone, iPad and Android mobile devices</li> </ol>
<b>■ Camera</b>	
Image Sensor	1/3" H.R. image sensor
Video Resolution	D1 / CIF
Min Illumination	0.1 Lux / F1.5
Shutter Speed	1 / 60 (1/50) to 1 / 100,000 sec.
S/N Ratio	More than 48dB (AGC off)
Lens	f3.8mm / F1.5
Viewing Angle	80.4°(Diagonal)
White Balance	ATW
AGC	Auto
IRIS Mode	AES
Power Source (±10%)	5V / 1A
Operating Temperature	0°C ~40°C
<b>■ Others</b>	
Mobile Surveillance	iPad, iPhone & Android
RTC (real-time clock)	YES
Motion Detection	YES
Event Notification	FTP / Email / SMS
Minimum Web Browsing Requirements	<ul style="list-style-type: none"> <li><input type="checkbox"/> Pentium 4 CPU 1.3 GHz or higher, or equivalent AMD</li> <li><input type="checkbox"/> 256 MB RAM</li> <li><input type="checkbox"/> AGP graphics card, Direct Draw, 32MB RAM</li> <li><input type="checkbox"/> Windows 7, Vista &amp; XP, DirectX 9.0 or later</li> <li><input type="checkbox"/> Internet Explorer 7.x or later</li> </ul>

\*\* The specifications are subject to change without notice.

\*\* Dimensional tolerance: ± 5mm

## APPENDIX 2 BIT RATE TABLE FOR REFERENCE

The data below is for reference only.

The bit rates listed here may vary depending on the resolution, image quality & frame rate you choose, the complexity of your monitoring area, and how often the moving objects show in your monitoring area.

### Testing Environment

- Place: Office Entrance
- Network translation: H.264



*Static: No one coming in and out*



*Dynamic: One or two people coming in and out*

Resolution	Quality	Frame Rate	(Dynamic) kbps	(Static) kbps
D1	Best	FULL	2786	1546
	High		1375	705
	Normal		1234	425
	Basic		441	245
CIF	Best		955	290
	High		364	171
	Normal		328	111
	Basic		161	68
D1	Best	1/5	935	474
	High		506	272
	Normal		297	175
	Basic		223	108
CIF	Best		222	109
	High		133	67
	Normal		81	49
	Basic		71	32
D1	Best	1/30	127	70
	High		197	20
	Normal		61	11
	Basic		50	4
CIF	Best		42	7
	High		38	2
	Normal		22	1
	Basic		28	0

## APPENDIX 3 API ID APPLICATION FOR SMS MESSAGING

To allow the camera automatically sending a text message when an event happens, you need to apply an API ID from Clickatell, one mobile messaging company, first.

**Note:** The SMS messaging is not totally free. You will be charged starting from the 11<sup>th</sup> message.

Please follow the steps below for application.

Step1: Go to <http://www.clickatell.com/login.php>. In “New Customers”, select “Clickatell Central (API)” from the drop-down list.

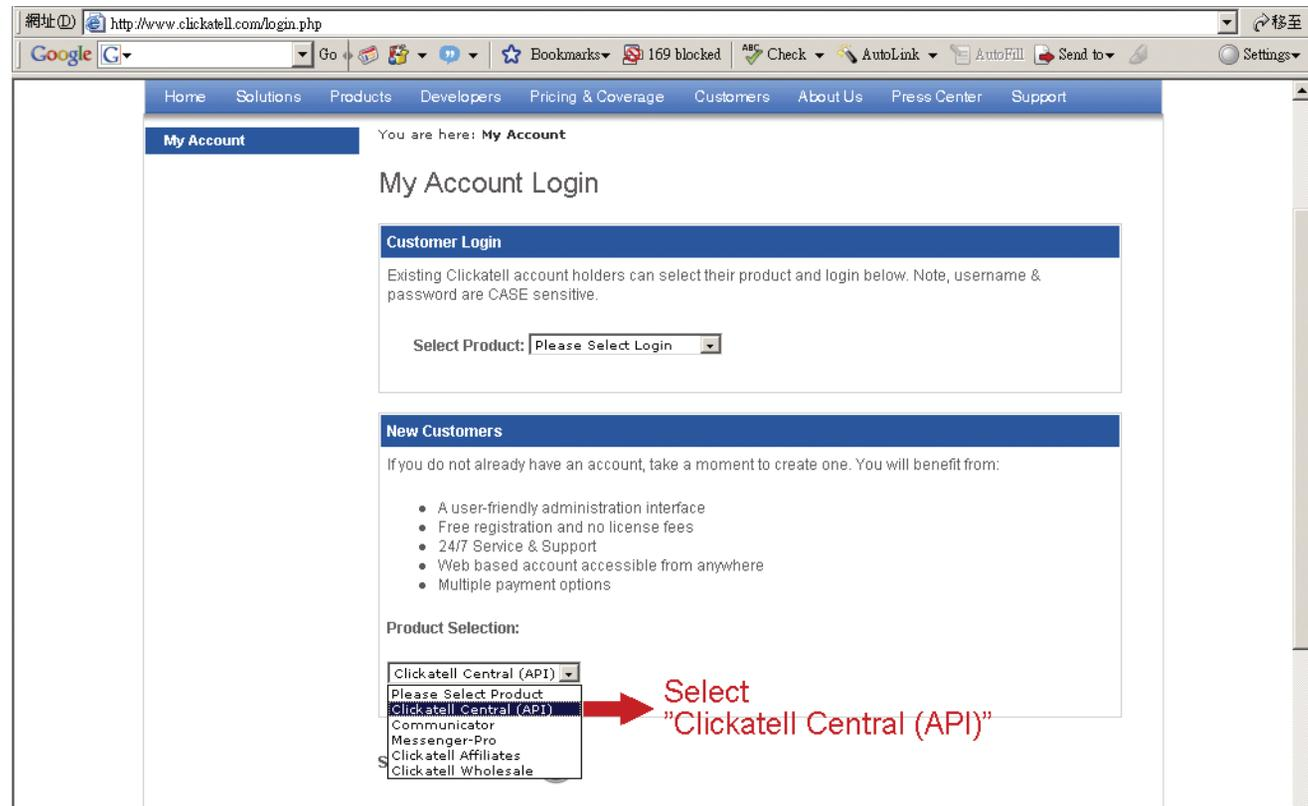

Step2: Fill in your information to create an account, and click “CONTINUE”.

**Note:** Note down the user name and password, and the mobile phone number you specified here for SMS notification setting later.

Step 1 of 4 - Select Product

Select one of the products below which you would like to register for:

Clickatell Central  Communicator

Step 2 of 4 - Account Setup

Select a country specific or International account type, based on your requirements for SMS traffic delivery destinations.

International Coverage Account:  Local Coverage Account:

INTERNATIONAL  USA  UK  SA  IN  IE

\* Create Username:  Security Code: 

\* Create Password:  \*Enter Security Code:

Step 3 of 4 - Personal Information

\*First Name:  \*Country:

\*Last Name:  \*Mobile Number:

\*Email Address:  (e.g. sample@domain.com)

Personal Use Only:

\* Company:  Job Description:

Company Size:  Industry:

Subindustry:

Emails sent to me must be in  Text format or  HTML format

Please send me a weekly update of my account balance via email newsletter

\* I accept Clickatell's [Terms and Conditions](#)

Step2: When the account is created, the system will automatically send an Email to your specified Email address and ask you to activate your account.

Click the link in the Email to complete account activation, and enter the login page as follows. Enter the password you set, and click “Login”.

### My Account Login

**Customer Login**  
Existing Clickatell account holders can select their product and login below. Note, username & password are CASE sensitive.

Select Product:

Username:

ClientID:

Password:

[Lost password?](#)

Enter the password you set to log in.

Step3: Enter the mobile phone number (including your country code) you want the text message to be sent, and click “SEND ACTIVATION CODE”. The system will send an activation code to that number for verification.

Check if you receive a text message from Clickatell.

**Verify your Mobile Number**

For security reasons you are required to verify your mobile number before you can receive non-test SMS messages.

Your activation code will be sent to

If this is not your number, please retype your mobile number in the box above and click the "Send Activation Code" button.

Enter your activation code here:

Enter your mobile phone number, including your country code.

Step4: Go back to Clickatell, and click the tab “Manage my Products”. Then, select “HTTP” from the drop-down list “My Connections”.

Central Home | My Settings | **Manage my Products** | Billing | Message Reports | Help

**Manage my Products**

**Test Message in Message Box**  
Please Note that Clickatell pre-populates all test credits with a standard test message. Once you have purchased Clickatell credits, the test message will be removed and you will be able to send personalized text messages.

**My Connections:**

**Add Connection**  
Add Connection  
**HTTP**  
SMTP  
FTP  
XML  
COM  
SMPP  
SOAP

Select "HTTP".

Step5: In “Add HTTP API”, enter a descriptive name for this service, and make sure the dial prefix is correct and callback type is “HTTP GET”. Then, click “Submit”.

**Add HTTP API - Bold Items Required**

Name:

IP Lock Down:

Dial Prefix:

Callback Type:

Callback Url:

Callback Username:

Callback Password:

Minimum information required

Step5: You will get an API ID as follows.

**Note:** Note down the API ID for SMS notification setting later.

My Connections:

Name	Type	API ID	Dialing Code
IP_SMS	SMTP API	3218637	886 Taiwan
IP_MSG	HTTP	3220810	886 Taiwan

1 to 2 of 2

## APPENDIX 4 Q&A

For more details about EagleEyes Q&A, please visit our official website: [www.eagleeyesctv.com/supp\\_QnA.aspx](http://www.eagleeyesctv.com/supp_QnA.aspx).

Question	Answer
<p>I can connect to this camera in my house or office where it's installed with wireless network.</p> <p>But when I leave my house or office, I can't connect to it from my mobile phone (with 3G network), or other PC (connected to Internet). Why?</p>	<p>You didn't configure this camera to Internet, but only in LAN.</p> <p>Please follow the steps in the advanced network setup guide to complete network configurations, or it's recommended for you to check with your local installer or reseller for this service because it's usually hard for a person who doesn't have network knowledge to set network configurations.</p>
<p>My live images are not fluent. Why?</p>	<p>Image fluency could be affected by the local network upload bandwidth, router efficiency, client network download bandwidth, complexity of live view, and more.</p> <p>To have better image fluency, select "CIF"; to have better image quality, select "D1".</p>
<p>My image is vague. Why?</p>	<p>The camera might lose its focus. Please rotate the lens to adjust.</p>
<p>The live video keeps flickering. Why?</p>	<p>Please try adjusting the power line frequency to "60 Hz" or "50 Hz" for the camera.</p> <p>For iPhone users, access the camera, and select "" on the top right corner to enter IPCAM Configuration page. Then, go to "Advance Setup" → "Camera" to change setting.</p> <p>For access from Internet Explorer, log into the camera, and select "Config." → "Camera" → "Video".</p>